

CAVIUS

PHOTOELECTRIC SMOKE ALARM

THE WORLD'S SMALLEST

WIRELESS 
ALARM FAMILY



10 YEAR
BATTERY
INCLUDED
NON-REPLACEABLE

PLEASE READ THIS USER GUIDE CAREFULLY

CAVIUS

CAVIUS Photoelectric Smoke Alarm

Part Code: 2107-002/10022/10026

Model: 2107-001

Recess Kit Part Code: 11014

**PLEASE READ THE USER GUIDE CAREFULLY BEFORE
INSTALLATION AND RETAIN FOR FUTURE USE.**

For large text option and maintenance guide visit

cavius.co.nz/resources or cavius.com.au/resources

TECHNICAL INFORMATION

The maximum number of CAVIUS Wireless Family alarms that can be interconnected within a house group are 32.

Please note: These must be alarms from the CAVIUS Wireless Family range.

WIRELESS 
ALARM FAMILY

The distance between interconnected alarms depends on the house layout and they should always be tested after installation. It is not advised to be more than 10m distance between two alarms.

Diameter: 78mm

Height: 43mm

The alarm is powered by two 3v CR123A lithium batteries.

Interconnected by RF: 926.365 MHz

Complies to standards: AS3786:2014/RCM



Alarm condition aural signal pattern according to ISO 8201.

2

1. The best areas to install an alarm:

- Install alarms on each floor of the house, in hallways and stairways.
- Alarms in each room such as bedrooms and living rooms.

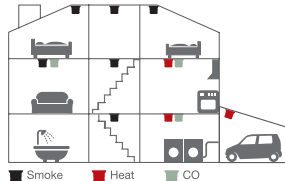

3

2. Areas where NOT to install smoke alarms:

- In dusty rooms
- At the top of a high pointed ceiling, in corners of a room, and within 50cm of where a ceiling and wall join.
- In rooms where the temperature goes outside +4c to 38c or above 90% relative humidity not condensing.
- In kitchens, garages, laundries, or too close to fireplaces; areas where either dampness, gases or heat could occur. Place the alarm where it is reachable in order to test the battery and for maintenance.

3. Placement:

The smoke alarm is designed to be installed on a ceiling (preferred) or wall.

Ceiling installation:

The smoke alarm should be a minimum of 50cm from the wall.

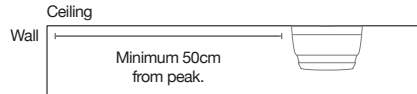

For cathedral or peak ceiling or wall installation:

For cathedral or peak ceiling; a minimum of 50cm from the peak

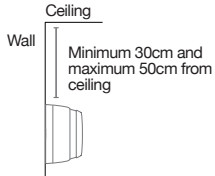
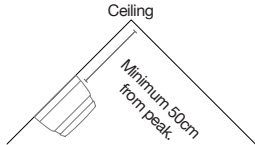

For wall installation; a minimum of 30cm and maximum of 50cm from the ceiling.

6

4. How to set up and connect alarms:

All alarms that need to be connected in the house should be put into 'Link Mode' by sliding the switch on the back of the alarm to the 'Link Mode' position.

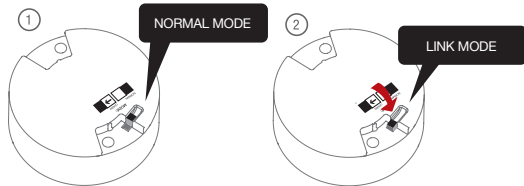

7

Press the button on the top of one alarm only. This alarm will become the 'Master' and will start sending out a specific house code to the other alarms (take note of which alarm is the 'Master', you may need this for adding extra devices in future). The red LED will flash.

As the other alarms receive the specific house code, they will also flash the LED light. When all alarms flash the red LED, they are connected and can be switched out of 'Link Mode' and installed.



Remove the Safety lock from the mounting base.

Place the Safety lock into the slot once the alarm has been clicked into the base. To remove the Safety lock in future, you will require a screwdriver and we advise to not be too forceful when removing.

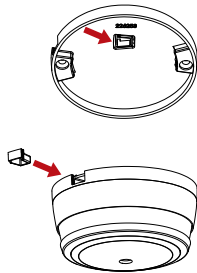

5. Installation of smoke alarm:

Info: The label on the product must not be removed due to important information.

Option 1 – Standard base

1. Use the mounting base ring to mark the screw holes on the ceiling.

10

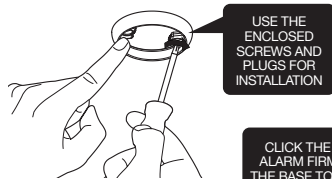
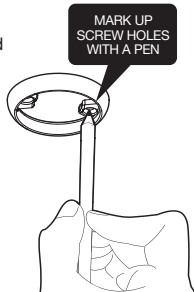

11

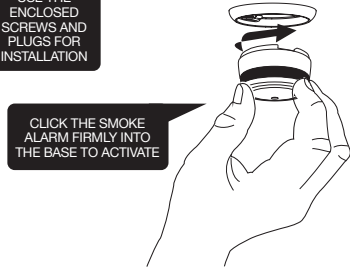

Option 2 – Recess Kit

1. Place the Cover Ring on the area where you wish to install the smoke alarm, trace around the inside of the ring.

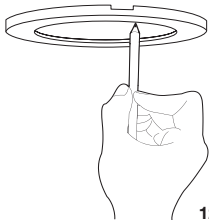

2. Using your hole saw (81mm-85mm), cut a hole into the surface.

CAUTION: Ensure there is no wiring or any electrical equipment behind the surface you are drilling your hole into.

NOTE: The Safety lock cannot be used when installing the alarm with the Recess Kit base option.

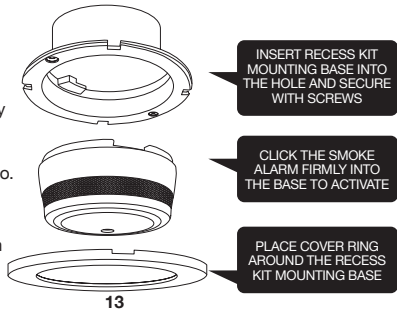

6. Test function:

After installation, and at least once per quarter, test all of your alarms to ensure they are operating correctly and are within range of each other.

It is recommended to check visually every week if the LED flashes correctly (every 48sec.)

Press the test button on any alarm for at least 6.5 seconds (count 2 sets of 3 sound sweeps). This will send out a test signal from the alarm; all other connected alarms should receive the signal within a short time. The alarms will emit a short beep and the LED will flash every 8 seconds for 2 minutes.

When the test signal is sent out, the alarms will respond in two ways:

1. A single beep every 8 seconds indicates that the alarms are connected and functioning.
2. Three short beeps every 8 seconds indicates a smoke sensor fault. The alarm should be cleaned by running the vacuum (on a low setting) around the smoke alarm chamber and tested again.

Once the alarms have indicated they are interconnected; the beeps can be stopped on each alarm with a short press of the test button.

TIP: It is safe to cover the sound output hole with your finger during the testing to minimise the sound level emitted.

If any problems occur during testing, visit www.cavius.co.nz or www.cavius.com.au for further trouble shooting.

7. Normal mode:

In normal mode the LED will flash every 48 seconds to show the alarm is functioning.

8. Alarm mode:

When a concentration of smoke is detected, the smoke alarm will go into 'Alarm Mode'. It will sound the alarm signal and the LED will flash. Please note that only the source alarm's LED will flash, so it can be identified.

The smoke alarm will also transmit the alarm signal to the other connected alarms, which will also sound the alarm signal after a short delay.

9. Hush function:

If the smoke alarms are to set into a false alarm by cooking, fireplace, etc. all of them can be paused for 10 minutes by pressing the test button on the originating smoke alarm only (indicated by the flashing LED).

You can hush each alarm individually, however the source alarm will continue to sound until hushed.

The reason for this is that it is necessary to locate the source of the alarm before using the hush function. This is to make sure that it is not a life threatening situation.

10. Add extra device:

All CAVIUS interconnected alarms within the



range can be added to the system as they run on the same frequency and use the same data protocol. This means that the wireless system can consist of a combination of smoke alarms and heat alarms.

Just place the 'Master' and new device into 'Link Mode', repeat Section 4.

Always test connection to all devices by repeating the test function (Section 7) after adding alarms.

Low battery indicator: A short acoustic “beep” will sound and the LED will flash every 48 seconds when the battery is near the end of its life. In this stage it will continue for a minimum of 30 days.

You must replace the smoke alarm after 10 years of use, or if the smoke alarm has suffered any damage. The smoke alarm is not active unless it is clicked into the mounting base.

Always test the smoke alarm after clicking into the mounting base, allow 5 seconds before testing.

FUNCTIONAL INFORMATION

Type of alarm: CAVIUS smoke alarm is a photoelectric smoke alarm.

Alarm signal: Fire alarm activation is indicated by a series of repeated tones. The minimum sound level is 85 dB at 3 metres.

Battery: Powered by two non-replaceable 3v CR123A, 1600mAh lithium batteries.



10 YEAR
BATTERY
INCLUDED
NON-REPLACEABLE

Developed & Manufactured by:

CAVIUS Aps

Julsøvej 16 - DK8600 Silkeborg

cavius.com - info@cavius.com

Manufactured in P.R.C.

Distributor information:

for New Zealand - CAVIUS Nano Ltd.

58a Poplar Lane, Papamoa 3187, NZ. www.cavius.co.nz

for Australia - CAVIUS Australia

14/30 Octal Street, Yatala, QLD 4207, Australia. www.cavius.com.au

Warranty:

CAVIUS provides a 10-year warranty against defect in faulty material and workmanship from the date of purchase, on all devices.

The warranty applies to reasonable and normal conditions of use only. It does not include damage as a result of misuse, incorrect installation, accidental damage, neglect, unauthorised deconstruction or dismantling and any airborne or other contamination however this may have occurred.

If this product has an acknowledged defect it must be returned to the national CAVIUS Distributor at the purchasers cost with the proof of purchase.

If the product has become defective within the 10-year warranty, CAVIUS APS, Denmark will repair or replace the unit without charge and send back to the purchaser, via the national Distributor at the Distributors cost.

The guarantee excludes labour costs, freight costs, service costs and any incidental and consequential damages. Do not attempt to repair or service this product as this will invalidate the warranty.

Under some unusual circumstances the presence of high levels of radio spectrum pollution may result in the batteries within the CAVIUS device not lasting as indicated in the product sheet. Radio spectrum pollution comprises transmissions inside the band allocated for alarm devices such as the CAVIUS devices. Such transmissions may activate the receiver inside the devices for a longer time than is normal in standby.

This is not a specific problem for CAVIUS devices but for all similar radio linked technology powered by batteries. The limited warranty will not cover the battery life period indicated in the product sheet in these situations.

This warranty is in lieu of any other warranty either expressed or implied.

You can register your CAVIUS devices on our website.

CAVIUS

PHOTOELECTRIC SMOKE ALARM

THE WORLD'S SMALLEST

WIRELESS 
ALARM FAMILY



10 YEAR
BATTERY
INCLUDED
NON-REPLACEABLE

PLEASE READ THIS USER GUIDE CAREFULLY